

Instruction Manual for Digital Centrifuge

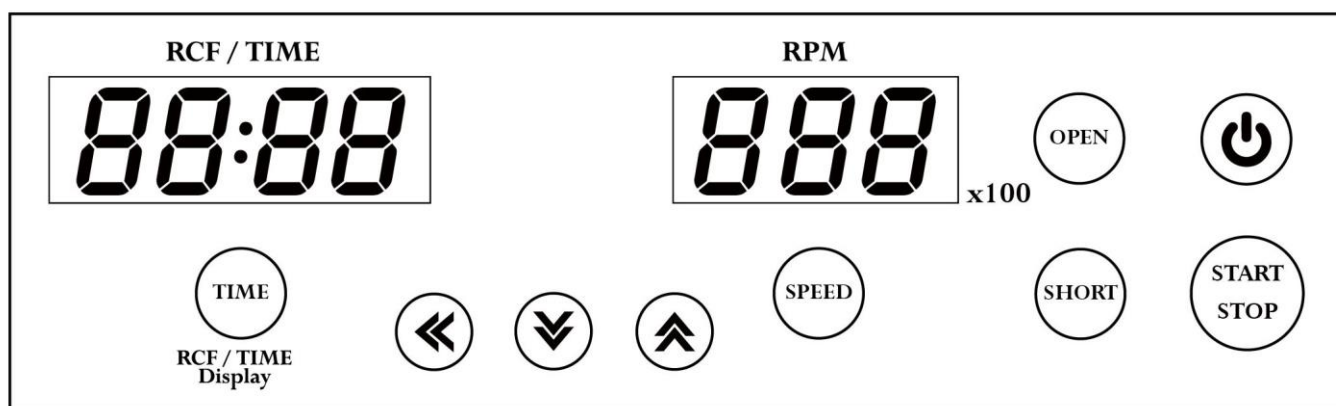

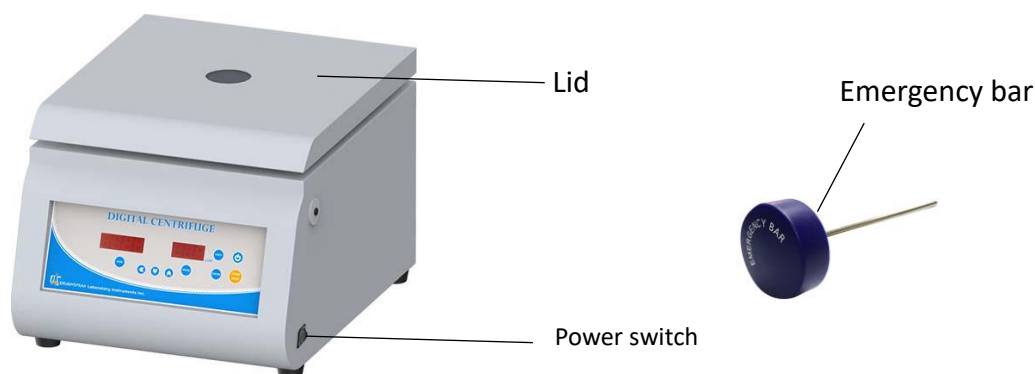





Control panel









Warnings:

- * Do not open the lid before the centrifuge stops completely.
- * Do not remove the centrifuge during operation.
- * Do not put objects on the top of the lid.
- * Do not disassemble the centrifuge by yourself. In the event of a malfunction, the centrifuge should be repaired by a qualified technician. Before repairing, turn off the power.

Steps:

1. Place the centrifuge on a flat surface. Plug the centrifuge into a properly grounded outlet. Turn on the power switch. The power indicator on the switch is illuminated.
2. Push the button , and then the screen is illuminated. Press the button  to open the lid. The screen shows icon "door". Insert an even number of tubes in a symmetrical position into the rotor.
3. Put down and press down the lid. Make sure the lid is closed well. The icon "door" will disappear on the screen.
4. Push the button , the speed value is flash one the screen. Push the button  or  or  to set the speed value. Push the button  or any other function button to enter the speed value.

When you setting the RPM value, you can monitor the RCF value on the RCF/TIME display screen.

5. Push the button , the time value is flash on the screen. Push the button  or  or  to set the time value. Push the button  or any other function button to enter the time value.
6. After setting parameters, push the button  to start the centrifuge. During operation, you can push the button  to stop the centrifuge. During operation, you can pus the button  to switch the remaining time or RCF value on the RCF/TIME display screen.
7. Push the button  to start the centrifuge directly. Release the button and the centrifuge will stop immediately. The centrifuge will run to the current speed setting value.
8. Under the conditions of power failure or the open function failure, please insert the “Emergency Bar” into the hole at right hand side of centrifuge to force the lid open.

Maintenance and care:

1. Keep the centrifuge clean all the time. Cleaning can be done with a damp cloth. Avoid the use of solvents as they may damage the product housing, rotor.
2. Check if the rotor is in the center. In case, the rotor is slanted. Stop using machine and contact the distributor for repair.

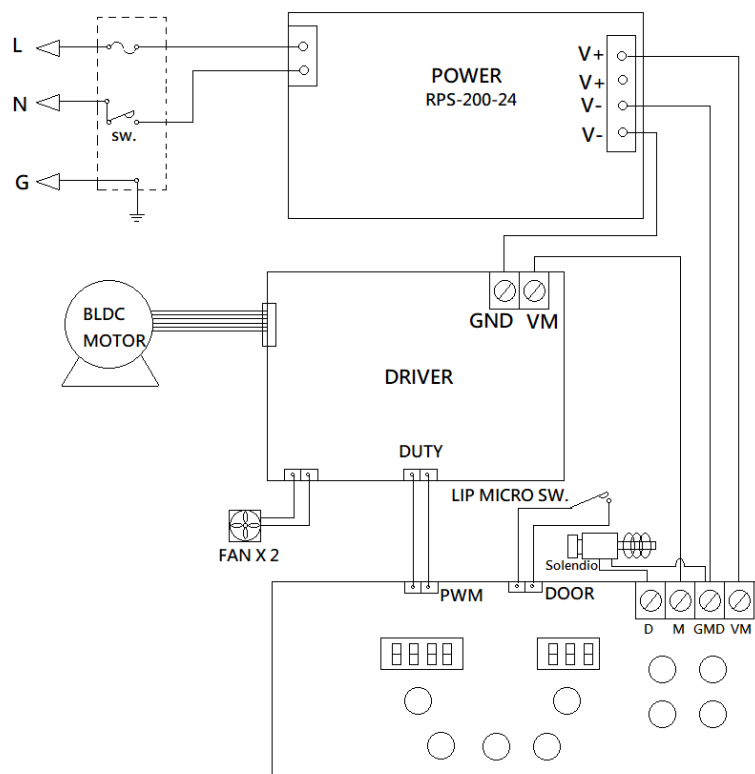

Circuit Diagram



Service Manual

Troubleshooting Guide

Caution: Always disconnect the power cord before troubleshooting.

Trouble / error message	Cause	Remedy
Motor doesn't work (Error message : Er-P)	<ol style="list-style-type: none"> 1. Speed sensor is defective. 2. Motor is defective. 3. Motor driver PC board is defective. 	<ol style="list-style-type: none"> 1. Contract the distributor for repair. 2. Contract the distributor for repair. 3. Contract the distributor for repair.
Motor is overshooting. (Error message: Er-E)	<ol style="list-style-type: none"> 1. Speed sensor is defective. 2. Motor is defective. 3. Motor driver PC board is defective. 	<ol style="list-style-type: none"> 1. Contract the distributor for repair. 2. Contract the distributor for repair. 3. Contract the distributor for repair.
Lid open error. (Error message : Er-d)	<ol style="list-style-type: none"> 1. During operation, the lid is open. 	<ol style="list-style-type: none"> 1. Waiting for the motor stop completely. And close the lid.
Speed value is not correct. (Error message: Er-r)	<ol style="list-style-type: none"> 1. Speed sensor is defective. 2. Motor is defective. 3. Motor driver PC board is defective. 	<ol style="list-style-type: none"> 1. Contract the distributor for repair. 2. Contract the distributor for repair. 3. Contract the distributor for repair.
Error message: run	<ol style="list-style-type: none"> 1. When the motor is rotating, push the button . 	<ol style="list-style-type: none"> 1. Waiting for motor stop completely, and then push the button , and then close the lid to restart the centrifuge.
No display on the screen	<ol style="list-style-type: none"> 1. Power is off. 2. Dead power output ° 3. Burnt fuse 4. PC board is defective. 	<ol style="list-style-type: none"> 1. Turn on the power. 2. Change to a different output. 3. Replace a new fuse. 4. Contract the distributor for repair.
Burnt fuse	<ol style="list-style-type: none"> 1. Fuse is wasted 2. Motor is defective. 3. PC board is defective. 	<ol style="list-style-type: none"> 1. Replace a new fuse. 2. Contract the distributor for repair. 3. Contract the distributor for repair.
Lid can't be open	<ol style="list-style-type: none"> 1. Lid lock is defective. 2. PC board is defective. 3. PC board is crashed. 	<ol style="list-style-type: none"> 1. Contract the distributor for repair. 2. Contract the distributor for repair. 3. Turn off the power, and turn on the power again. Push the button  to open the lid.